

 **katena**
DESIGNED FOR SIGHT®

INSTRUMENTS
BIOLOGICS
DEVICES



K9 ケース等



About Us:

Katena is the largest independently owned American company dedicated exclusively to ophthalmic surgical instrumentation. Katena markets its products directly to customers in the United States and through a global network of distributors in more than 110 countries around the world.

Established 1975, Katena is committed to:

- Developing innovative instruments to support new surgical techniques and technological advances in the field of ophthalmology.
- Producing instruments of consistently excellent quality.
- Providing unexcelled service to its customers and strong support for its distributors worldwide.

お知らせ

このカタログの商品は、できる限り番号順に記載されています。目次は、カタログ番号の最初につく番号（例えばK1, K2・・・）によって、製品のグループを特定しています。

このカタログの写真は特に注記したものを除き実物大です。イラストは細部を示す為の拡大図です。

このカタログに記載されている手術用鋼製小物は、特に注記してあるもの以外はステンレススチール製です。

すべての仕様は、予告なしに変更される場合があります。

このカタログに使用されている写真、イラストおよびテキストは著作権で保護されており、カティーナ社の書面による同意なく複製できません。

Katena®, K-Sponge®, Performance™, Phaco-4™, Ultrakleen™, Designed for Sight™は、Katena Products社の登録商標です。

IOPatch, BioElevation, BioDome, Ambio5, keraSys and tarSys are registered trademarks of Innovative Ophthalmic Products, Inc. Ambio2 and AmbioDisk are trademarks of Innovative Ophthalmic Products, Inc. SutureGroove is a registered trademark of Advanced Meditech International – and is used with permission. Tutoplast is a registered trademark of Tutogen Medical – and is used with permission.

STAAR®, ICL™はカリフォルニア州モンロビアのSTAAR Surgical社の登録商標です。

IntraLase®はカリフォルニア州アーバインのIntraLase®社の登録商標です。



Accessories

サージバンドマーキングテープ

Marking Tape

autoclavable

For identifying surgical instruments.

K9-1000 red	K9-1050 brown
K9-1010 yellow	K9-1060 blue
K9-1020 orange	K9-1070 green
K9-1030 white	K9-1071 lime green
K9-1035 grey	K9-1080 fluorescent orange
K9-1040 black	K9-1090 fluorescent purple



チップガード

有孔 100個入

Vented Tip Guards

autoclavable (pk/100)

For protecting tips of surgical instruments.

K9-1205 assorted colors
K9-1215 white
K9-1225 blue
K9-1235 green
K9-1245 red
K9-1255 yellow
K9-1265 orange

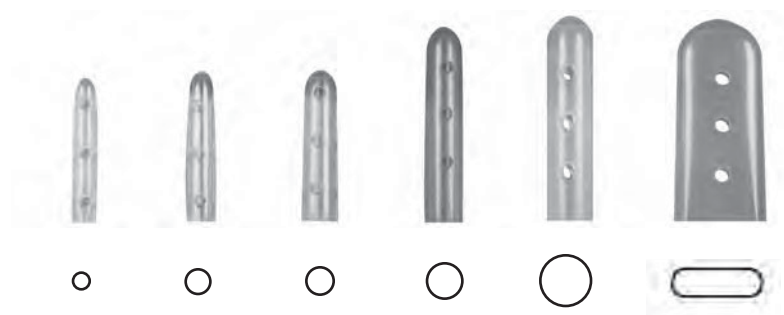

この品目は取扱っておりません。

Squeeze Handle

Cleaning Tube

used to flush delicate
mechanized instruments
luer lock connector provided

K9-1350



Sterilizing Cases • Plastic

滅菌ケース

ダイヤモンドナイフ用

Sterilizing Case for Diamond Knife

autoclavable plastic
with perforated silicone rack

K2-6555 for one knife

K2-6556 for two knives

Millimeters

Inches

160 x 60 x 25

6 ¼" x 2 ¼" x 1"



プラスチック製滅菌ケース

Plastic Sterilizing Cases

autoclavable plastic
with silicone finger mat
base, lid and mat are perforated
for steam penetration

Catalog #

Size

of Instruments

Millimeters

Inches

K9-2018

small, narrow

1-2

195 x 60 x 25

7 ⅝" x 2 ¼" x 1"

K9-2020

small

2-3

160 x 70 x 25

6 ¼" x 2 ¾" x 1"

K9-2025

medium

4-6

200 x 110 x 25

7 ¾" x 4 ¼" x 1"

K9-2030

large

10-15

265 x 160 x 25

10 ⅜" x 6 ⅜" x 1"

K9-2040

large, double level

20-25

265 x 160 x 50

10 ⅜" x 6 ⅜" x 2"



K9-2020

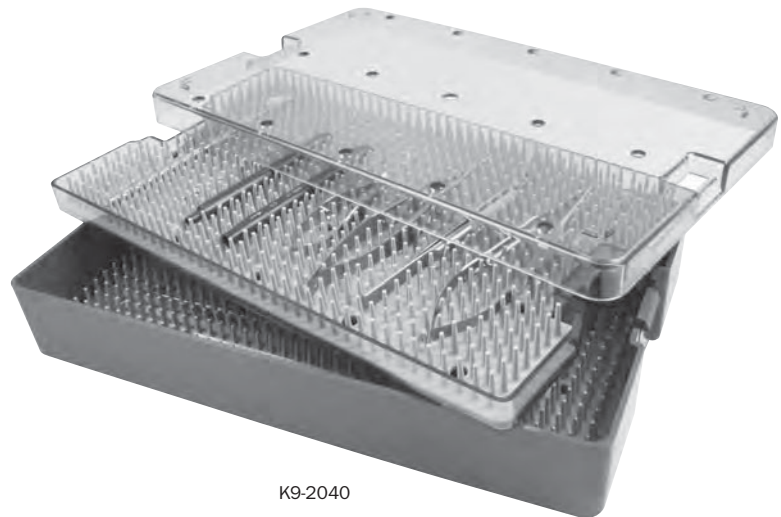

K9-2040

Sterilizing Cases • Plastic

ダイヤモンドナイフ用滅菌ケース

Sterilizing Case

autoclavable plastic
with perforated silicone rack
base, lid and rack are perforated
for steam penetration

Accommodates 1 instrument.

K9-2022

Millimeters

158 x 70 x 25

Inches

6 ¼" x 2 ¾" x 1"



滅菌ケース

ナイフ用

Sterilizing Case for Knives

autoclavable plastic
with silicone racks
base and lid are perforated
for steam penetration

Accommodates 3 knives.

K9-2024

Millimeters

198 x 70 x 25

Inches

7 ¾" x 2 ¾" x 1"



Sterilizing Cases • Stainless Steel

ステンレス滅菌ケース

小 8 ~12本用

Katena Sterilizing Case, small

stainless steel

base, lid and mat are perforated
for steam penetration

Accommodates 8 to 12
microsurgical instruments.

K9-2100 complete

K9-2120 silicone mat only シリコンマットのみ

Millimeters

Inches

210 x 125 x 20

8 ¼" x 5" x ¾"



ステンレス滅菌ケース

中 20~25本用

Katena Sterilizing Case, medium

stainless steel

base, lid and mats are perforated
for steam penetration

includes 2 silicone mats, rack for
4 cannulas and a rack for 4 delicate
hooks or knives

Accommodates 20 to 25
microsurgical instruments.

K9-2200

Millimeters

Inches

320 x 220 x 20

12 ½" x 8 ¾" x ¾"

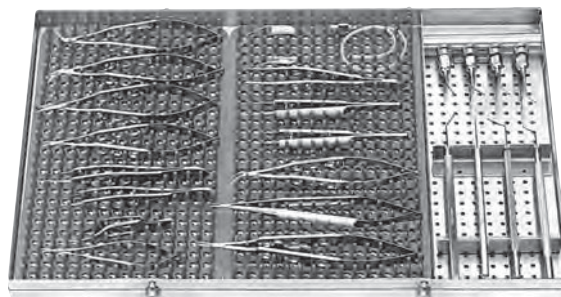

ステンレス滅菌ケース

大 30~40本用

Katena Sterilizing Case, large

stainless steel

base, lid and mats are perforated
for steam penetration

includes 3 silicone mats, racks for 8
cannulas and
a rack for 4 delicate hooks or knives

Accommodates 30 to 40
microsurgical instruments.

K9-2300

Millimeters

Inches

360 x 295 x 20

14 ¼" x 11 ½" x ¾"

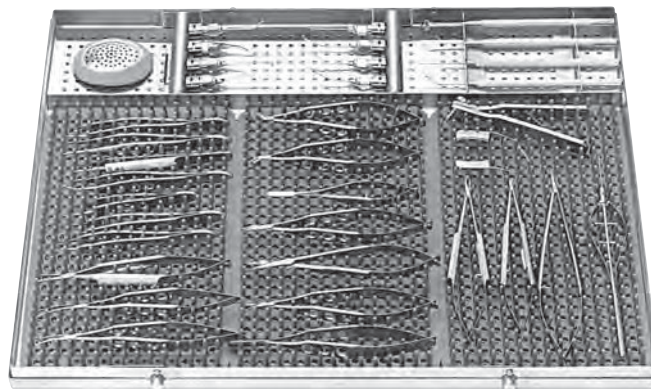

Sterilizing Cases • Aluminum

アルミニウム製滅菌ケース

Aluminum Sterilizing Cases, single

autoclavable anodized aluminum
with silicone finger mat
base, lid, and mat are perforated
for steam penetration

Catalog #	Size	# of Instruments	Millimeters	Inches
K9-2320	small	6-8	206 x 115 x 19	8 1/8" x 4 1/2" x 3/4"
K9-2330	medium	10-17	247 x 206 x 19	9 3/4" x 8 1/8" x 3/4"
K9-2340	large	16-20	327 x 225 x 25	12 7/8" x 8 7/8" x 1"

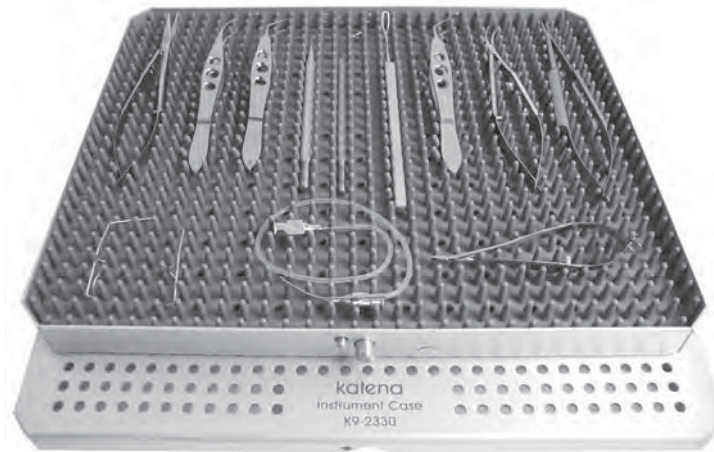

追加マット

Silicone Finger Mat

with "S-Channels" on underside
*Utilizing a special design which improves air flow
beneath the mat, making the drying process more
efficient and thorough.*

K9-2325 for use with Instrument Case,
aluminum, small (K9-2320)

K9-2335 for use with Instrument Case,
aluminum, medium (K9-2330)

K9-2345 for use with Instrument Case,
aluminum, large (K9-2340)

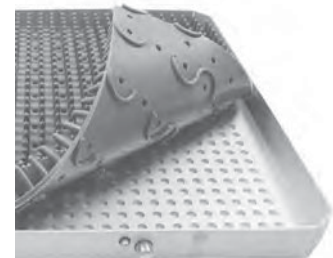

Sterilizing Cases • Aluminum

アルミニウム製滅菌ケース

Aluminum Sterilizing Case, double

anodized aluminum
double level with a side
compartment for larger items
includes removable tray and 4
silicone mats
base, lid, tray and mats are
perforated for steam penetration
Accommodates 35 to 50
microsurgical instruments.

K9-2350

Millimeters

325 x 265 x 42

Inches

12 $\frac{3}{4}$ " x 10 $\frac{1}{2}$ " x 1 $\frac{5}{8}$ "

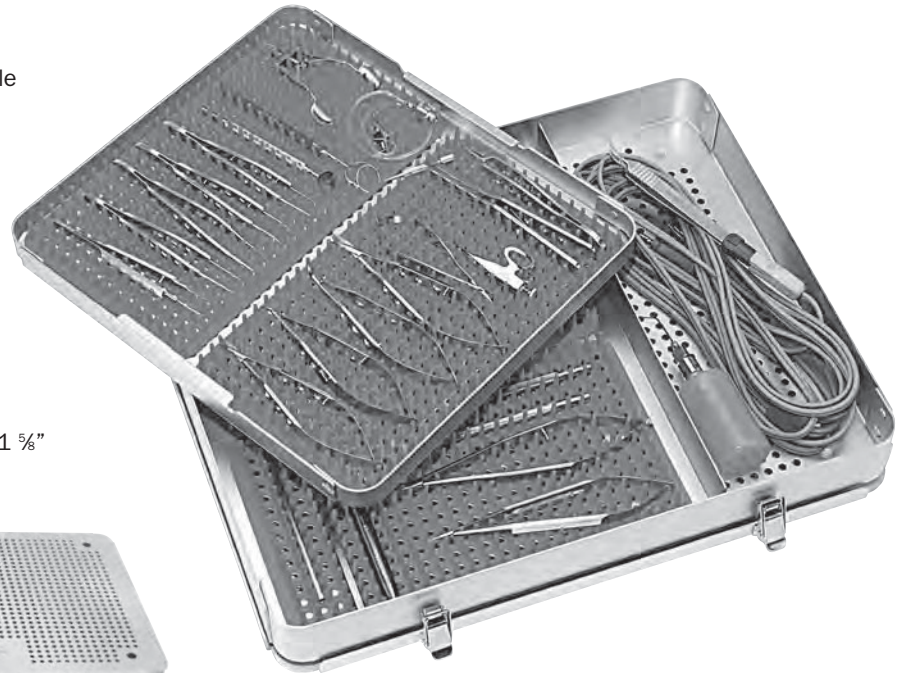
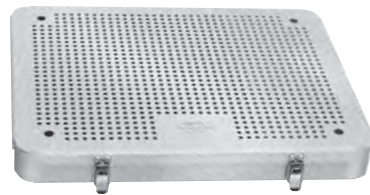

インスツルメントラック

Instrument Rack

anodized aluminum
Holds and protects delicate hooks,
manipulators and cannulas. Fits into
upper or lower tray of double level
sterilizing
case (K9-2350) shown above
Accommodates 5 cannulas, 6 hooks,
manipulators, etc.

K9-2355

Millimeters

202 x 115 x 15

Inches

8" x 4 $\frac{1}{2}$ " x $\frac{1}{2}$ "



INSTRUMENT RACK IN TRAY

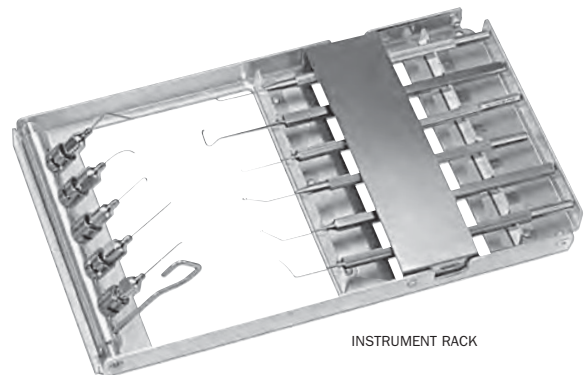

INSTRUMENT RACK

Eye Shields

フォックス保護眼帯
アルミニウム製 50個入

Fox

Aluminum
Eye Shield
(bx/50)

K9-6000

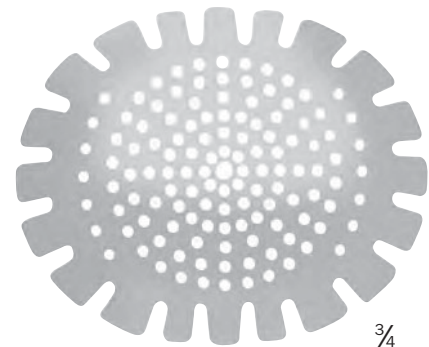

¾

アルミニウム製保護眼帯
ガーター付 50個入

Fox

Aluminum Eye Shield
with garter
assorted colors
(bx/50)

K9-6010 adult 大人用

K9-6015 pediatric 小児用

K9-6030 garter only, assorted* ガーターのみ 各色取合せ

K9-6040 garter only, white* ガーターのみ 白

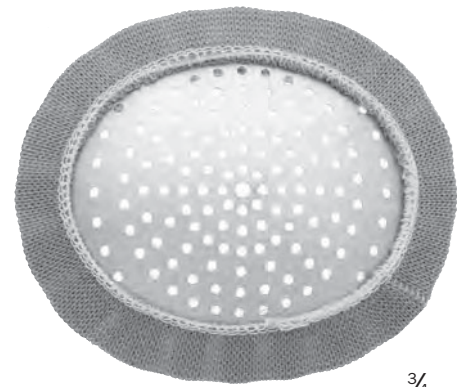

¾

*Caution: Garters contain latex which may cause allergic reactions.
注：ガーターにはアレルギーの原因になる場合があるラテックスが含まれています。

万能保護眼帯
透明プラスチック製 12個入

Universal

Eye Shield
clear plastic
(pk/12)

K9-6050

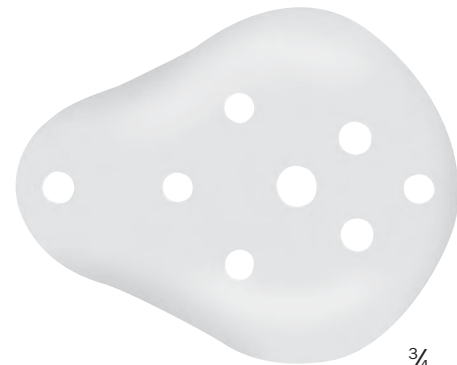

¾

Pressure Reducer

ピンホール型保護眼帯
白プラスチック製 12個入

Pin Hole

Eye Shield
white plastic
(pk/12)

K9-6100

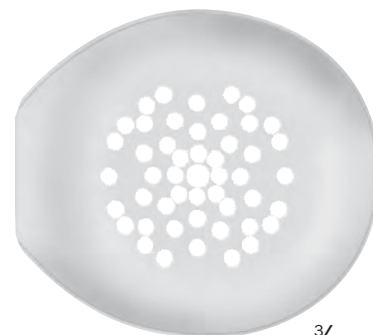

3/4

この品目は取扱っておりません。

Honan Balloon

Intraocular Pressure Reducer
with relief valve

K9-8410 complete*

K9-8411 headband only, reusable*

K9-8412 headband, latex free
disposable (bx/12)



*Caution: This product contains latex which may cause allergic reactions.